

MU ADAPTORS

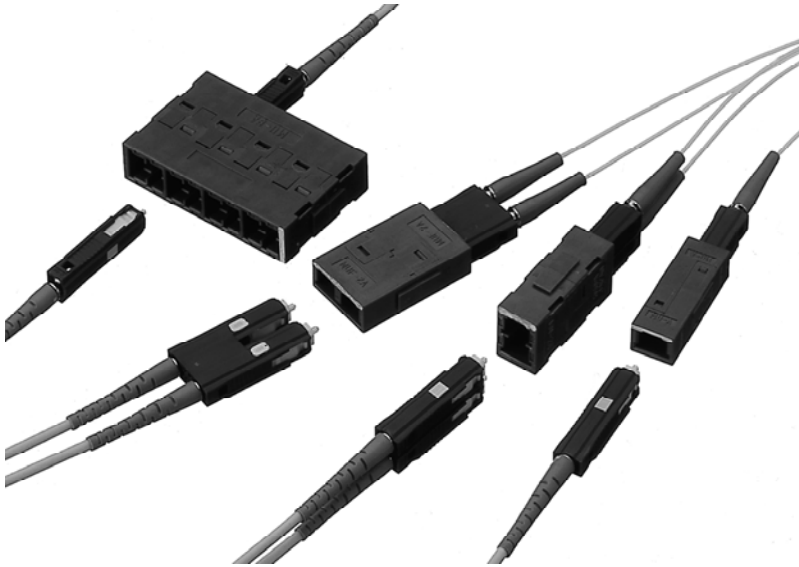

Stratos' MU adaptors are designed to save space in advanced communications applications and are equipped with zirconia sleeves for high-precision alignment. Our wide range of adaptors are available in 1-port, 2-port, 4-port, 8-port, and 16-port configurations. A wide variety of mounting styles are available that include press fit, flange mount, or a combination of both mounting options. MU adaptors are NTT and JIS compliant.

Features

- High precision alignment
- High density package
- Small form factor
- Corrosion resistant
- NTT and JIS compliant

Applications

- CATV
- Telecommunication networks
- Metro networks
- Local area networks (LANs)
- Data processing networks
- Board/panel mounting
- Industrial, military and medical
- High-density applications

Specifications



Test Item	Requirement Condition	JIS C 5961 Test Method
Insertion Loss	IL.: $\leq 0.4\text{dB}$	Wavelength 1310nm
Engagement and Separation Force (using 1-port plug)	1-port: $\leq 20\text{ N}$ 2-port: $\leq 30\text{ N}$	
Change of Temperature	Ins. Loss after test: $\leq .5\text{dB}$	Temperature: $-25\text{C}\sim 70\text{C}$ Test duration: 1.5h/cycle, 100 cycles
Humidity (Cyclic)		Humidity: $93\pm 3\%$ Test duration: 24h/cycle, 20 cycles
Dry Heat		Temperature: 85C Test duration 240 hours
Cold		Temperature: -25C Test duration: 240 hours

Compact Adaptor

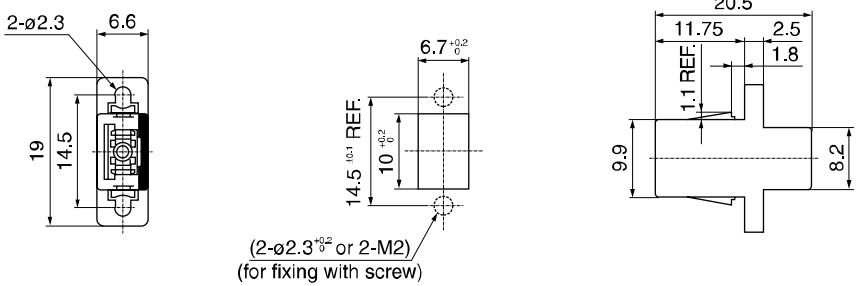

1-Port Compact Adaptor (Press Fit/Flange Mount)

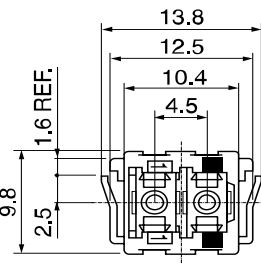
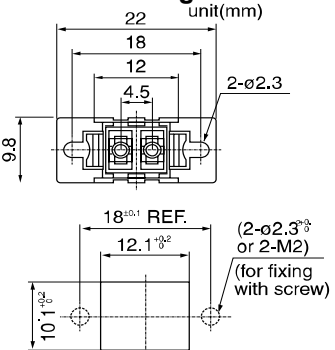
	Press Fit/Flange Mount	
		Mounting Hole Size t=1.6
1-Port	Part Number 396-00167-00	Mounting Type Press Fit/Flange Mount

2-Port Compact Adaptor (Press Fit/Flange Mount)

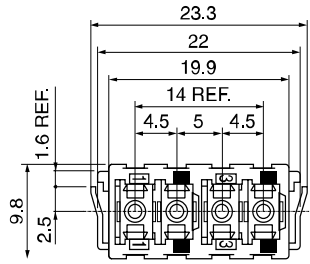
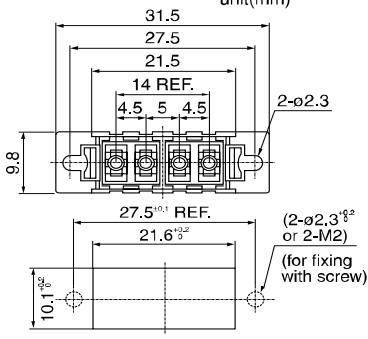

Press Fit/Flange Mount	Press Fit unit(mm)	Press Fit/Flange Mount unit(mm)
		
Press Fit		Mounting Hole Size t=1.6
2-Port	Part Number 396-00168-00 396-00169-00	Mounting Type Press Fit Press Fit/Flange Mount

4-Port Compact Adaptor (Press Fit/Flange Mount)

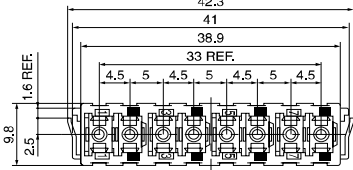
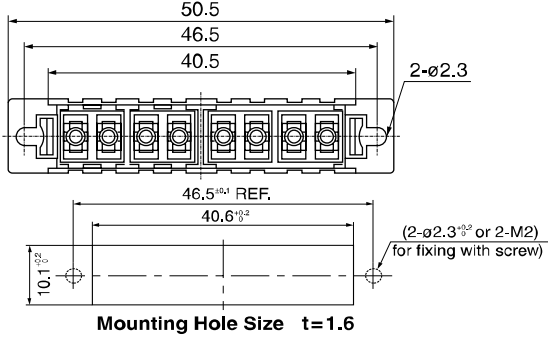

Press Fit/Flange Mount	Press Fit unit(mm)	Press Fit/Flange Mount unit(mm)
		
Press Fit		Mounting Hole Size t=1.6
4-Port	Part Number 396-00170-00 396-00171-00	Mounting Type Press Fit Press Fit/Flange Mount

Compact Adaptors

8-Port Compact Adaptor (Press Fit/Flange Mount)

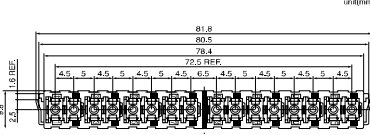
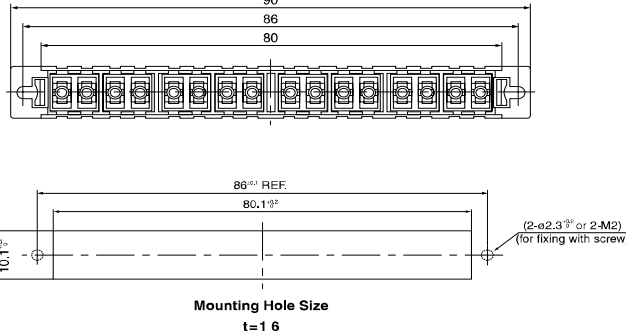

<p>Press Fit/Flange Mount</p> 	<p>Press Fit</p> 	<p>Press Fit/Flange Mount unit(mm)</p> 
<p>Press Fit</p> 		
<p>8-Port</p>	<p>Part Number 396-00172-00 396-00173-00</p>	<p>Mounting Type Press Fit Press Fit/Flange Mount</p>

16-Port Compact Adaptor (Press Fit/Flange Mount)

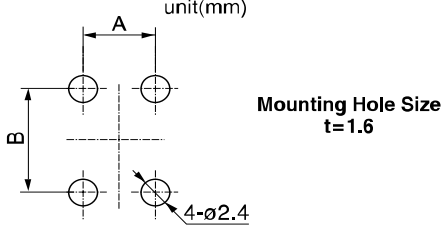

<p>Press Fit/Flange Mount</p> 	<p>Press Fit</p> 	<p>Press Fit/Flange Mount</p> 
<p>Press Fit</p> 		
<p>16-Port</p>	<p>Part Number 396-00174-00 396-00175-00</p>	<p>Mounting Type Press Fit Press Fit/Flange Mount</p>

Adaptor with Metal Brackets

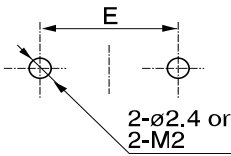
Adaptors w/ Metal Brackets (Board Mounting)

<p><u>Press Fit</u></p> 	<p>unit(mm)</p>  <p>(1-Port Example)</p>		
<p><u>Flange Mount</u></p> 	<p>unit(mm)</p>  <p>(1-Port Example)</p>		
<p>Board Mounting Adaptors</p>	<p>Part Number</p>	<p>Number of Ports</p>	<p>Bracket Type</p>
	<p>396-00114-00</p>	<p>1</p>	<p>Press Fit</p>
	<p>396-00116-00</p>	<p>1</p>	<p>Flange Mount</p>
	<p>396-00119-00</p>	<p>2</p>	<p>Press Fit</p>
	<p>396-00121-00</p>	<p>2</p>	<p>Flange Mount</p>
	<p>396-00124-00</p>	<p>8</p>	<p>Press Fit</p>
	<p>396-00126-00</p>	<p>8</p>	<p>Flange Mount</p>

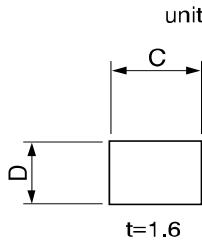
Adaptors w/ Metal Brackets (Panel Mounting)

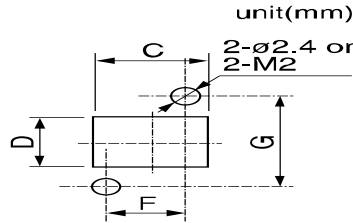
<p><u>Press Fit</u></p> 	<p>unit(mm)</p>  <p>(1-Port Example)</p>		
<p><u>Flange Mount</u></p> 	<p>unit(mm)</p>  <p>(1-Port Example)</p>		
<p>Panel Mounting Adaptors</p>	<p>Part Number</p>	<p>Number of Ports</p>	<p>Bracket Type</p>
	<p>396-00115-00</p>	<p>1</p>	<p>Press Fit</p>
	<p>396-00117-00</p>	<p>1</p>	<p>Flange Mount</p>
	<p>396-00120-00</p>	<p>2</p>	<p>Press Fit</p>
	<p>396-00122-00</p>	<p>2</p>	<p>Flange Mount</p>
	<p>396-00125-00</p>	<p>8</p>	<p>Press Fit</p>
	<p>396-00127-00</p>	<p>8</p>	<p>Flange Mount</p>

